

# Wheels and castors for pallet trucks, forklift trucks and other industrial trucks



## Selection tool

### Wheels and castors for pallet trucks, forklift trucks and other industrial trucks



Series	HTH / RK-HTH, HTHW	HB / RK-HB	HPO
	Rollers for pallet trucks		
Tread / tyre	Polyurethane-elastomer Blickle Extrathane®	Polyurethane-elastomer Blickle Besthane®	Nylon
Tread and tyre hardness	92 Shore A	92 Shore A	70 Shore D
Wheel centre / rim	metal	metal	–
Wheel Ø	60–90 mm	80–85 mm	80–85 mm
Load capacity up to	1,130 kg	960 kg	1,100 kg
Speeds up to	4 km/h	4 km/h	4 km/h
For a description of the wheel, refer to	page 560–562, 564–565	page 563	page 566



ALEV	ALST	ALTH	PO
Front wheels for pallet trucks			
Elastic solid rubber, smooth rolling quality, "Blickle EasyRoll"	Polyurethane-elastomer Blickle Softhane®	Polyurethane-elastomer Blickle Extrathane®	Nylon
65 Shore A	75 Shore A	92 Shore A	70 Shore D
aluminium	aluminium	aluminium	nylon
200 mm	200 mm	180–200 mm	200 mm
500 kg	700 kg	800 kg	600 kg
10 km/h	10 km/h	10 km/h	4 km/h
page 567	page 567	page 567	page 567

## Selection tool

### Wheels and castors for pallet trucks, forklift trucks and other industrial trucks

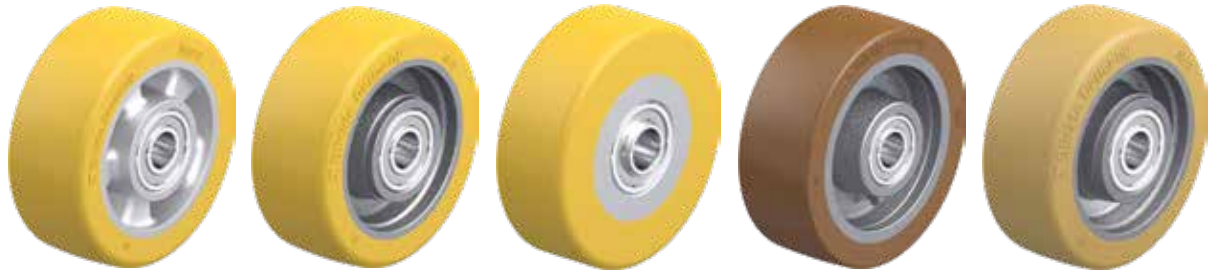

Series	ALTH	GTH	VSTH	GB	GVU
	Heavy-duty wheels for use on industrial trucks				
Tread / tyre	Polyurethane-elastomer Blickle Extrathane®	Polyurethane-elastomer Blickle Extrathane®	Polyurethane-elastomer Blickle Extrathane®	Polyurethane-elastomer Blickle Besthane®	Vulkollan®
Tread and tyre hardness	92 Shore A	92 Shore A	92 Shore A	92 Shore A	92 Shore A
Wheel centre / rim	aluminium	grey cast iron	steel	grey cast iron	grey cast iron
Wheel Ø	100–140 mm	100–180 mm	100–125 mm	100–180 mm	100–180 mm
Load capacity up to	800 kg	1,100 kg	540 kg	1,200 kg	1,200 kg
Speeds up to	10 km/h	10 km/h	4 km/h	16 km/h	16 km/h
For a description of the wheel, refer to	page 568	page 568	page 568	page 569	page 570



REV	RTH	RB	RVU
Wheels for stackers, drive and running wheels for forklift trucks			
Elastic solid rubber	Polyurethane-elastomer Blickle Extrathane®	Polyurethane-elastomer Blickle Besthane®	Vulkollan®
70 Shore A	92 Shore A	92 Shore A	92 Shore A
grey cast iron	grey cast iron	grey cast iron	grey cast iron
215–254 mm	200–270 mm	230–343 mm	230–250 mm
–	–	–	–
16 km/h	10 km/h	16 km/h	16 km/h
page 571–574, 576	page 571–579	page 571–575, 578–579	page 576, 578

# HTH series, dimensions 60x35-82x65 mm

Rollers for pallet trucks with Blickle Extrathane® polyurethane tread, with metal wheel centre

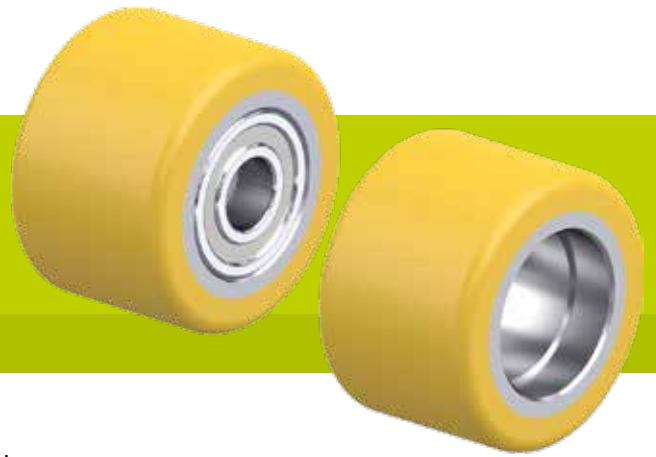

220–850 kg

**Tread and tyre hardness**  
 92 Shore A

**Smooth operation / floor preservation**  
 good

**Rolling resistance**  
 very good

**Wear resistance**  
 excellent

- Tread:**
- high-quality polyurethane elastomer Blickle Extrathane®, hardness 92 Shore A
  - low rolling resistance
  - high abrasion resistance
  - high cut and tear propagation resistance
  - colour light brown, non-marking, non-staining
  - excellent chemical connection with the wheel centre

- Wheel centre:**
- metal

- Other features:**
- high chemical resistance to many aggressive substances
  - operating temperature: -20 °C to +70 °C, temporarily up to +90 °C, reduced load capacity over +40 °C

- Additional details:**
- wheel series: page 78
  - tread: page 55
  - bearing types: page 84–85
  - chemical resistance: page 51



Rollers for pallet trucks with ball bearing	Wheel Ø (D) [mm]	Wheel width (T2) [mm]	Axle bore Ø (d) [mm]	Clamping length (T5) [mm]	ball bearing	Rollers for pallet trucks without ball bearing	Bearing seating Ø (S) [mm]	Bearing seating depth (t) [mm]	Load capacity [kg]
HTH 60x35/15-35K	60	35	15	35	6002 ZZ	RK-HTH 060x035/32x09-35-Z	32	9	220
HTH 60x60/10-56K	60	60	10	56	6200 2RS	RK-HTH 060x060/30x11-60-Z	30	11	400
HTH 75x40/20-40K	75	40	20	40	6204 ZZ	RK-HTH 075x040/47x14-40-Z	47	14	340
HTH 75x62/20-62K	75	62	20	62	6204 ZZ	RK-HTH 075x062/47x14-62-Z	47	14	510
HTH 75x75/20-75K	75	75	20	75	6204 ZZ	RK-HTH 075x075/47x14-75-Z	47	14	630
HTH 75x95/20-95K	75	95	20	95	6204 ZZ	RK-HTH 075x095/47x14-95-Z	47	14	800
HTH 80x30/12-27K	80	30	12	27	6201 ZZ	RK-HTH 080x030/32x12-30-Z	32	12	260
HTH 80x40/20-40K	80	40	20	40	6204 ZZ	RK-HTH 080x040/47x14-40-Z	47	14	350
HTH 80x54/20-54K	80	54	20	54	6204 ZZ	RK-HTH 080x054/47x14-54-Z	47	14	480
HTH 80x54/20-60K	80	54	20	60	6204 ZZV	RK-HTH 080x054/47x14-54-Z	47	14	480
HTH 80x56/20-56K	80	56	20	56	6204 ZZ	RK-HTH 080x056/47x14-56-Z	47	14	500
HTH 80x60/20-66K	80	60	20	66	6204 ZZV	RK-HTH 080x060/47x12-60-Z	47	12	530
HTH 80x62/20-54K	80	62	20	54	6204 ZZ	RK-HTH 080x062/47x18-62-Z	47	18	550
HTH 80x70/20-70K	80	70	20	70	6204 ZZ	RK-HTH 080x070/47x14-70-Z	47	14	630
HTH 80x74/20-68K	80	74	20	68	6004 ZZ	RK-HTH 080x074/42x14-72-Z *	42	14	660
HTH 80x80/20-80K	80	80	20	80	6204 ZZ	RK-HTH 080x080/47x14-80-Z	47	14	720
HTH 80x95/20-89K	80	95	20	89	6004 ZZ	RK-HTH 080x095/42x14-93-Z *	42	14	850
HTH 82x28/12-26K	82	28	12	26	6201 ZZ	RK-HTH 082x028/32x11-28-Z	32	11	250
HTH 82x34/12-32K	82	34	12	32	6201 ZZ	RK-HTH 082x034/32x11-34-Z	32	11	310
HTH 82x50/20-52K	82	50	20	52	6204 ZZ	RK-HTH 082x050/47x13-50-Z	47	13	450
HTH 82x60/20-56K	82	60	20	56	6204 ZZ	RK-HTH 082x060/47x16-60-Z	47	16	550
HTH 82x60/20-60K	82	60	20	60	6204 ZZ	RK-HTH 082x060/47x14-60-Z	47	14	550
HTH 82x60/25-52K	82	60	25	52	6205 ZZ	RK-HTH 082x060/52x19-60-Z	52	19	550
HTH 82x60/25-60K	82	60	25	60	6005 ZZ	RK-HTH 082x060/47x14-60-Z	47	14	550
HTH 82x62/20-64K	82	62	20	64	6204 ZZ	RK-HTH 082x062/47x13-62-Z	47	13	560
HTH 82x65/20-65K	82	65	20	65	6204 ZZ	RK-HTH 082x065/47x14-65-Z	47	14	590
HTH 82x65/20-71K	82	65	20	71	6204 ZZV	RK-HTH 082x065/47x14-65-Z	47	14	590

\* Hub recessed

For other dimensions, please refer to the next page

## Versions / options

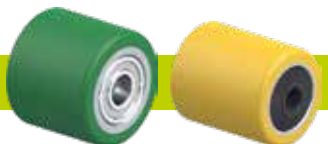

with Blickle Softhane® polyurethane tread      splash and washproof version

Technical description page	55	79
Product code suffix	<b>HST series</b>	<b>HTHW series</b>
Available for	upon request**	see page 564–565

\*\* Hardness 75 Shore A

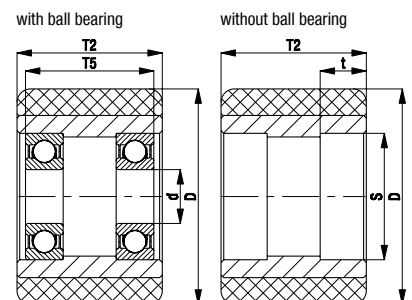

# HTH series, dimensions 82x70-85x75 mm

## Rollers for pallet trucks with Blickle Extrathane® polyurethane tread, with metal wheel centre

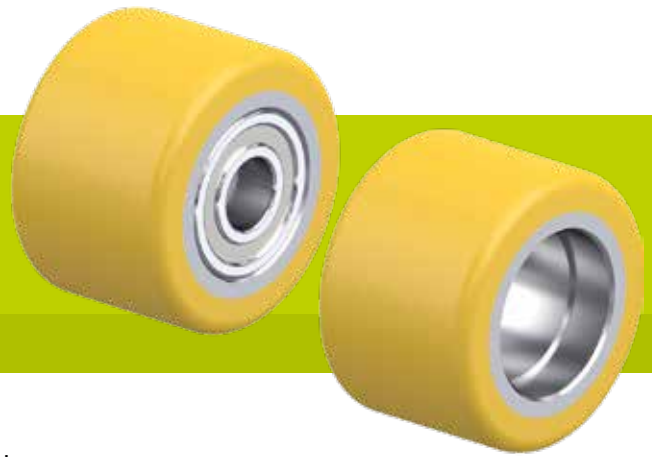

460–1,070 kg

**Tread and tyre hardness**  
 92 Shore A

**Smooth operation / floor preservation**  
 good

**Rolling resistance**  
 very good

**Wear resistance**  
 excellent

- Tread:**
- high-quality polyurethane elastomer Blickle Extrathane®, hardness 92 Shore A
  - low rolling resistance
  - high abrasion resistance
  - high cut and tear propagation resistance
  - colour light brown, non-marking, non-staining
  - excellent chemical connection with the wheel centre

- Wheel centre:**
- metal

- Other features:**
- high chemical resistance to many aggressive substances
  - operating temperature: -20 °C to +70 °C, temporarily up to +90 °C, reduced load capacity over +40 °C

- Additional details:**
- wheel series: page 78
  - tread: page 55
  - bearing types: page 84–85
  - chemical resistance: page 51



Rollers for pallet trucks with ball bearing	Wheel Ø (D) [mm]	Wheel width (T2) [mm]	Axle bore Ø (d) [mm]	Clamping length (T5) [mm]	ball bearing	Rollers for pallet trucks without ball bearing	Bearing seating Ø (S) [mm]	Bearing seating depth (t) [mm]	Load capacity [kg]
HTH 82x70/20-62K	82	70	20	62	6204 ZZ	RK-HTH 082x070/47x18-70-Z	47	18	640
HTH 82x70/20-70K	82	70	20	70	6204 ZZ	RK-HTH 082x070/47x14-70-Z	47	14	640
HTH 82x70/20-72K	82	70	20	72	6204 ZZV	RK-HTH 082x070/47x14-70-Z	47	14	640
HTH 82x70/20-76K	82	70	20	76	6204 ZZV	RK-HTH 082x070/47x12-70-Z	47	12	640
HTH 82x72/20-72K	82	72	20	72	6204 ZZ	RK-HTH 082x072/47x14-72-Z	47	14	660
HTH 82x72/20-74K	82	72	20	74	6204 ZZV	RK-HTH 082x072/47x14-72-Z	47	14	660
HTH 82x72/20-78K	82	72	20	78	6204 ZZV	RK-HTH 082x072/47x14-72-Z	47	14	660
HTH 82x80/20-80K	82	80	20	80	6204 ZZ	RK-HTH 082x080/47x14-80-Z	47	14	730
HTH 82x82/20-86K	82	82	20	86	6204 ZZV	RK-HTH 082x082/47x13-82-Z	47	13	750
HTH 82x89/20-82K	82	89	20	82	6204 ZZ	RK-HTH 082x089/47x18-89-Z	47	17.5	820
HTH 82x90/20-90K	82	90	20	90	6204 ZZ	RK-HTH 082x090/47x14-90-Z	47	14	830
HTH 82x90/20-96K	82	90	20	96	6204 ZZV	RK-HTH 082x090/47x14-90-Z	47	14	830
HTH 82x98/20-98K	82	98	20	98	6204 ZZ	RK-HTH 082x098/47x14-98-Z	47	14	910
HTH 82x100/20-96K	82	100	20	96	6204 ZZ	RK-HTH 082x100/47x16-100-Z	47	16	920
HTH 82x100/20-100K	82	100	20	100	6204 ZZ	RK-HTH 082x100/47x14-100-Z	47	14	920
HTH 82x100/20-104K	82	100	20	104	6204 ZZV	RK-HTH 082x100/47x14-100-Z	47	14	920
HTH 83x83/25-83K	83	83	25	83	6205 ZZ	RK-HTH 083x083/52x15-83-Z	52	15	780
HTH 83x115/30-114K	83	115	30	114	6206 ZZ	RK-HTH 083x115/62x17-115-Z	62	16.5	1,070
HTH 84x74/17-78K *	84	74	17	78	6006 2RS	RK-HTH 084x074/55x23-74-Z	55	23	690
HTH 85x50/20-50K	85	50	20	50	6204 ZZ	RK-HTH 085x050/47x14-50-Z	47	14	460
HTH 85x50/25-50K	85	50	25	50	6005 ZZ	RK-HTH 085x050/47x14-50-Z	47	14	460
HTH 85x60/17-60K	85	60	17	60	6303 ZZ	RK-HTH 085x060/47x14-60-Z	47	14	560
HTH 85x60/20-60K	85	60	20	60	6204 ZZ	RK-HTH 085x060/47x14-60-Z	47	14	560
HTH 85x60/20-65K	85	60	20	65	6204 ZZV	RK-HTH 085x060/47x14-60-Z	47	14	560
HTH 85x65/20-65K	85	65	20	65	6204 ZZ	RK-HTH 085x065/47x14-65-Z	47	14	610
HTH 85x70/17-70K	85	70	17	70	6303 ZZ	RK-HTH 085x070/47x14-70-Z	47	14	660
HTH 85x70/20-70K	85	70	20	70	6204 ZZ	RK-HTH 085x070/47x14-70-Z	47	14	660
HTH 85x70/20-75K	85	70	20	75	6204 ZZV	RK-HTH 085x070/47x14-70-Z	47	14	660
HTH 85x75/17-75K	85	75	17	75	6303 ZZ	RK-HTH 085x075/47x14-75-Z	47	14	720
HTH 85x75/20-75K	85	75	20	75	6204 ZZ	RK-HTH 085x075/47x14-75-Z	47	14	720
HTH 85x75/25-75K	85	75	25	75	6005 ZZ	RK-HTH 085x075/47x14-75-Z	47	14	720

\* With nylon socket

For other dimensions, please refer to the next page

### Versions / options

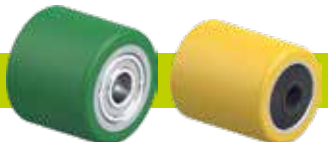

with Blickle Softhane® polyurethane tread splash and washproof version

Technical description page	55	79
Product code suffix	<b>HST series</b>	<b>HTHW series</b>
Available for	upon request**	see page 564–565

\*\* Hardness 75 Shore A

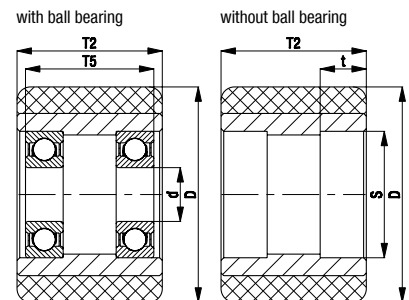

# HTH series, dimensions 85x75-90x50 mm

## Rollers for pallet trucks with Blickle Extrathane® polyurethane tread, with metal wheel centre

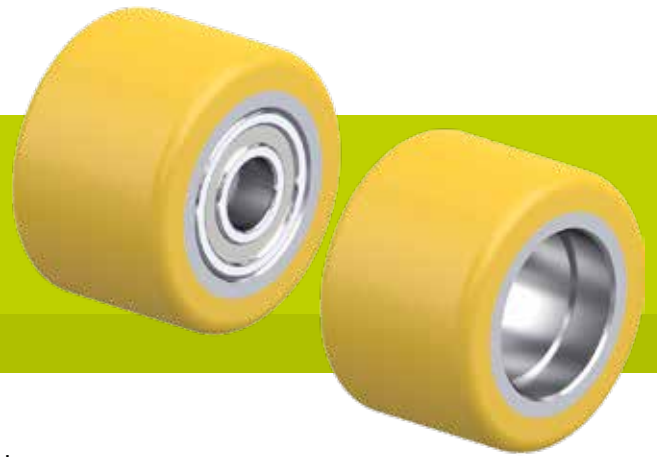

420–1,130 kg

**Tread and tyre hardness**  
 92 Shore A

**Smooth operation / floor preservation**  
 good

**Rolling resistance**  
 very good

**Wear resistance**  
 excellent

- Tread:**
- high-quality polyurethane elastomer Blickle Extrathane®, hardness 92 Shore A
  - low rolling resistance
  - high abrasion resistance
  - high cut and tear propagation resistance
  - colour light brown, non-marking, non-staining
  - excellent chemical connection with the wheel centre

- Wheel centre:**
- metal

- Other features:**
- high chemical resistance to many aggressive substances
  - operating temperature: -20 °C to +70 °C, temporarily up to +90 °C, reduced load capacity over +40 °C

- Additional details:**
- wheel series: page 78
  - tread: page 55
  - bearing types: page 84–85
  - chemical resistance: page 51



Rollers for pallet trucks with ball bearing	Wheel Ø (D) [mm]	Wheel width (T2) [mm]	Axle bore Ø (d) [mm]	Clamping length (T5) [mm]	Ball bearing	Rollers for pallet trucks without ball bearing	Bearing seating Ø (S) [mm]	Bearing seating depth (t) [mm]	Load capacity [kg]
HTH 85x75/20-77K	85	75	20	77	6204 ZZV	RK-HTH 085x075/47x14-75-Z	47	14	720
HTH 85x75/20-79K	85	75	20	79	6204 ZZV	RK-HTH 085x075/47x15-75-Z	47	15	720
HTH 85x78/20-78K	85	78	20	78	6204 ZZ	RK-HTH 085x078/47x14-78-Z	47	14	740
HTH 85x80/17-82K	85	80	17	82	6303 ZZ	RK-HTH 085x080/47x14-80-Z	47	14	770
HTH 85x80/20-80K	85	80	20	80	6204 ZZ	RK-HTH 085x080/47x14-80-Z	47	14	770
HTH 85x80/20-85K	85	80	20	85	6204 ZZV	RK-HTH 085x080/47x14-80-Z	47	14	770
HTH 85x80/25-74K	85	80	25	74	6205 ZZ	RK-HTH 085x080/52x18-80-Z	52	18	770
HTH 85x80/25-80K	85	80	25	80	6005 ZZ	RK-HTH 085x080/47x14-80-Z	47	14	770
HTH 85x80/25-85K	85	80	25	85	6005 ZZV	RK-HTH 085x080/47x14-80-Z	47	14	770
HTH 85x85/20-85K	85	85	20	85	6204 ZZ	RK-HTH 085x085/47x14-85-Z	47	14	820
HTH 85x85/25-85K	85	85	25	85	6005 ZZ	RK-HTH 085x085/47x14-85-Z	47	14	820
HTH 85x87/17-89K	85	87	17	89	6303 ZZ	RK-HTH 085x087/47x14-87-Z	47	14	830
HTH 85x90/17-90K	85	90	17	90	6303 ZZ	RK-HTH 085x090/47x14-90-Z	47	14	850
HTH 85x90/20-90K	85	90	20	90	6204 ZZ	RK-HTH 085x090/47x14-90-Z	47	14	850
HTH 85x95/20-95K	85	95	20	95	6204 ZZ	RK-HTH 085x095/47x14-95-Z	47	14	910
HTH 85x95/20-100K	85	95	20	100	6204 ZZV	RK-HTH 085x095/47x14-95-Z	47	14	910
HTH 85x100/17-100K	85	100	17	100	6303 ZZ	RK-HTH 085x100/47x14-100-Z	47	14	960
HTH 85x100/20-100K	85	100	20	100	6204 ZZ	RK-HTH 085x100/47x14-100-Z	47	14	960
HTH 85x100/20-102K	85	100	20	102	6204 ZZV	RK-HTH 085x100/47x14-100-Z	47	14	960
HTH 85x100/20-104K	85	100	20	104	6204 ZZV	RK-HTH 085x100/47x15-100-Z	47	15	960
HTH 85x100/25-100K	85	100	25	100	6005 ZZ	RK-HTH 085x100/47x14-100-Z	47	14	960
HTH 85x100/25-104K	85	100	25	104	6005 ZZV	RK-HTH 085x100/47x14-100-Z	47	14	960
HTH 85x105/25-110K	85	105	25	110	6005 ZZV	RK-HTH 085x105/47x13-105-Z	47	12.5	1,010
HTH 85x110/25-110K	85	110	25	110	6005 ZZ	RK-HTH 085x110/47x14-110-Z	47	14	1,060
HTH 85x110/25-114K	85	110	25	114	6005 ZZV	RK-HTH 085x110/47x14-110-Z	47	14	1,060
HTH 85x120/25-124K	85	120	25	124	6005 ZZV	RK-HTH 085x120/47x14-120-Z	47	14	1,130
HTH 90x42/20-40K	90	42	20	40	6204 ZZ	RK-HTH 090x042/47x15-42-Z	47	15	420
HTH 90x50/20-48K	90	50	20	48	6204 ZZ	RK-HTH 090x050/47x15-50-Z	47	15	500

Other dimensions available upon request

### Versions / options

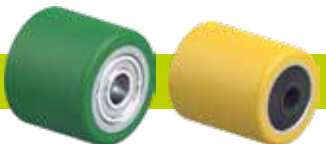

	with Blickle Softhane® polyurethane tread	splash and washproof version
Technical description page	55	79
Product code suffix	<b>HST series</b>	<b>HTHW series</b>
Available for	upon request*	see page 564–565

\* Hardness 75 Shore A

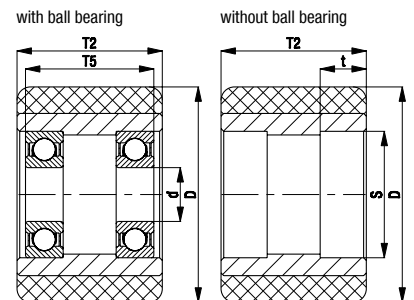



## HB series

Rollers for pallet trucks with  
Blickle Besthane® polyurethane tread,  
with metal wheel centre

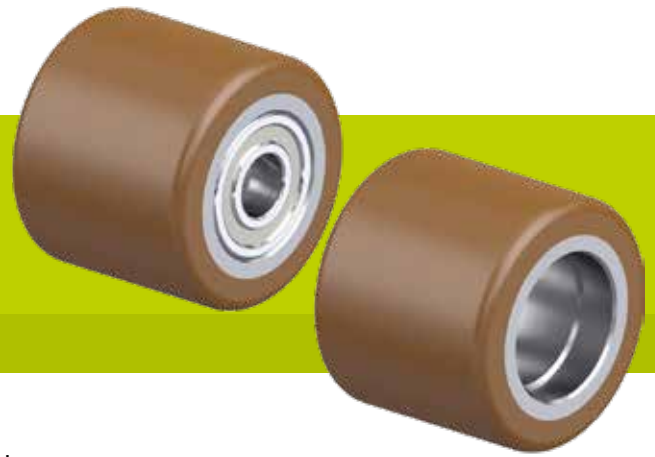

550–960 kg

### Tread and tyre hardness



92 Shore A

### Smooth operation / floor preservation



good

### Rolling resistance



excellent

### Wear resistance



excellent

### Tread:

- high-quality polyurethane elastomer Blickle Besthane®, hardness 92 Shore A
- very low rolling resistance
- **high dynamic load capacity**
- high abrasion resistance
- high cut and tear propagation resistance
- colour brown, non-marking, non-staining
- excellent chemical connection with the wheel centre

### Wheel centre:

- metal

### Other features:

- high chemical resistance to many aggressive substances
- operating temperature: -20 °C to +70 °C, temporarily up to +90 °C, reduced load capacity over +40 °C

### Additional details:

- wheel series: page 78
- tread: page 56
- bearing types: page 84–85
- chemical resistance: page 51



Rollers for pallet trucks with ball bearing	Wheel Ø (D) [mm]	Wheel width (T2) [mm]	Axle bore Ø (d) [mm]	Clamping length (T5) [mm]	Ball bearing	Rollers for pallet trucks without ball bearing	Bearing seating Ø (S) [mm]	Bearing seating depth (t) [mm]	Load capacity [kg]
HB 80x70/20-70K	80	70	20	70	6204 ZZ	RK-HB 080x070/47x14-70-Z	47	14	630
HB 82x60/20-60K	82	60	20	60	6204 ZZ	RK-HB 082x060/47x14-60-Z	47	14	550
HB 82x60/25-60K	82	60	25	60	6005 ZZ	RK-HB 082x060/47x14-60-Z	47	14	550
HB 82x65/20-65K	82	65	20	65	6204 ZZ	RK-HB 082x065/47x14-65-Z	47	14	590
HB 82x65/20-71K	82	65	20	71	6204 ZZV	RK-HB 082x065/47x14-65-Z	47	14	590
HB 82x70/20-70K	82	70	20	70	6204 ZZ	RK-HB 082x070/47x14-70-Z	47	14	640
HB 82x70/20-72K	82	70	20	72	6204 ZZV	RK-HB 082x070/47x14-70-Z	47	14	640
HB 82x100/20-100K	82	100	20	100	6204 ZZ	RK-HB 082x100/47x14-100-Z	47	14	920
HB 82x100/20-104K	82	100	20	104	6204 ZZV	RK-HB 082x100/47x14-100-Z	47	14	920
HB 85x60/17-60K	85	60	17	60	6303 ZZ	RK-HB 085x060/47x14-60-Z	47	14	560
HB 85x60/20-60K	85	60	20	60	6204 ZZ	RK-HB 085x060/47x14-60-Z	47	14	560
HB 85x60/20-65K	85	60	20	65	6204 ZZV	RK-HB 085x060/47x14-60-Z	47	14	560
HB 85x70/17-70K	85	70	17	70	6303 ZZ	RK-HB 085x070/47x14-70-Z	47	14	660
HB 85x70/20-70K	85	70	20	70	6204 ZZ	RK-HB 085x070/47x14-70-Z	47	14	660
HB 85x70/20-75K	85	70	20	75	6204 ZZV	RK-HB 085x070/47x14-70-Z	47	14	660
HB 85x75/17-75K	85	75	17	75	6303 ZZ	RK-HB 085x075/47x14-75-Z	47	14	720
HB 85x75/20-75K	85	75	20	75	6204 ZZ	RK-HB 085x075/47x14-75-Z	47	14	720
HB 85x75/25-75K	85	75	25	75	6005 ZZ	RK-HB 085x075/47x14-75-Z	47	14	720
HB 85x80/17-82K	85	80	17	82	6303 ZZ	RK-HB 085x080/47x14-80-Z	47	14	770
HB 85x80/20-80K	85	80	20	80	6204 ZZ	RK-HB 085x080/47x14-80-Z	47	14	770
HB 85x80/20-85K	85	80	20	85	6204 ZZV	RK-HB 085x080/47x14-80-Z	47	14	770
HB 85x80/25-80K	85	80	25	80	6005 ZZ	RK-HB 085x080/47x14-80-Z	47	14	770
HB 85x80/25-85K	85	80	25	85	6005 ZZV	RK-HB 085x080/47x14-80-Z	47	14	770
HB 85x90/17-90K	85	90	17	90	6303 ZZ	RK-HB 085x090/47x14-90-Z	47	14	850
HB 85x90/20-90K	85	90	20	90	6204 ZZ	RK-HB 085x090/47x14-90-Z	47	14	850
HB 85x100/17-100K	85	100	17	100	6303 ZZ	RK-HB 085x100/47x14-100-Z	47	14	960
HB 85x100/20-100K	85	100	20	100	6204 ZZ	RK-HB 085x100/47x14-100-Z	47	14	960
HB 85x100/20-102K	85	100	20	102	6204 ZZV	RK-HB 085x100/47x14-100-Z	47	14	960
HB 85x100/25-100K	85	100	25	100	6005 ZZ	RK-HB 085x100/47x14-100-Z	47	14	960

Other dimensions available upon request

## Versions / options

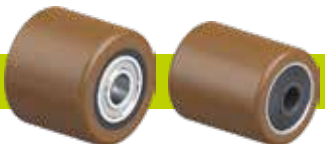

	hydrolysis resistant, with nylon wheel centre	splash and washproof version
Technical description page	56	56
Product code suffix	<b>HPOB series</b>	<b>HBW series</b>
Available for	upon request	upon request

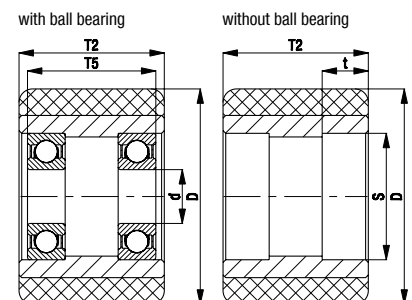

## HTHW series, dimensions 82x60-85x80 mm

**Rollers for pallet trucks with Blickle Extrathane® polyurethane tread, metal wheel centre, splash and washproof**



550–1,010 kg

**Tread and tyre hardness**

92 Shore A

**Smooth operation / floor preservation**

good

**Rolling resistance**

very good

**Wear resistance**

excellent



**Tread:**

- high-quality polyurethane elastomer Blickle Extrathane®, hardness 92 Shore A
- low rolling resistance
- high abrasion resistance
- high cut and tear propagation resistance
- colour light brown, non-marking, non-staining
- excellent chemical connection with the wheel centre

**Wheel centre:**

- metal

**Other features:**

- high chemical resistance to many aggressive substances
- operating temperature: -20 °C to +70 °C, temporarily up to +90 °C, reduced load capacity over +40 °C
- optimal splash and washproof for ball bearing through combination of clearance sealing and slipping sealing

**Additional details:**

- wheel series: page 79
- tread: page 55
- bearing types: page 84–85
- chemical resistance: page 51

Rollers for pallet trucks	Wheel Ø (D) [mm]	Wheel width (T2) [mm]	Load capacity [kg]	Bearing type	Axle bore Ø (d) [mm]	Clamping length (T5) [mm]
HTHW 82x60/12-64K	82	60	550	ball bearing	12	64
HTHW 82x60/20-64K	82	60	550	ball bearing	20	64
HTHW 82x70/20-74K	82	70	640	ball bearing	20	74
HTHW 82x82/20-86K	82	82	750	ball bearing	20	86
HTHW 82x100/20-104K	82	100	920	ball bearing	20	104
HTHW 82x110/25-115K	82	110	1,010	ball bearing	25	115
HTHW 85x60/12-65K	85	60	560	ball bearing	12	65
HTHW 85x60/17-65K	85	60	560	ball bearing	17	65
HTHW 85x60/20-65K	85	60	560	ball bearing	20	65
HTHW 85x60/25-65K	85	60	560	ball bearing	25	65
HTHW 85x65/12-70K	85	65	610	ball bearing	12	70
HTHW 85x65/17-70K	85	65	610	ball bearing	17	70
HTHW 85x65/20-70K	85	65	610	ball bearing	20	70
HTHW 85x65/25-70K	85	65	610	ball bearing	25	70
HTHW 85x70/12-75K	85	70	660	ball bearing	12	75
HTHW 85x70/17-75K	85	70	660	ball bearing	17	75
HTHW 85x70/20-75K	85	70	660	ball bearing	20	75
HTHW 85x70/25-75K	85	70	660	ball bearing	25	75
HTHW 85x75/12-80K	85	75	720	ball bearing	12	80
HTHW 85x75/17-80K	85	75	720	ball bearing	17	80
HTHW 85x75/20-80K	85	75	720	ball bearing	20	80
HTHW 85x75/25-80K	85	75	720	ball bearing	25	80
HTHW 85x80/12-85K	85	80	770	ball bearing	12	85
HTHW 85x80/17-82K	85	80	770	ball bearing	17	82
HTHW 85x80/17-85K	85	80	770	ball bearing	17	85
HTHW 85x80/20-85K	85	80	770	ball bearing	20	85
HTHW 85x80/25-85K	85	80	770	ball bearing	25	85

For other dimensions, please refer to the next page

### Versions / options

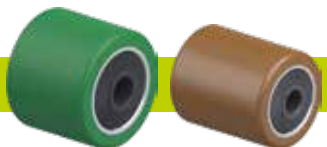

with Blickle Softhane® polyurethane tread	with Blickle Besthane® polyurethane tread
---	---

Technical description page	55	56
<b>Product code suffix</b>	<b>HSTW series</b>	<b>HBW series</b>
Available for	upon request*	upon request

\* Hardness 75 Shore A

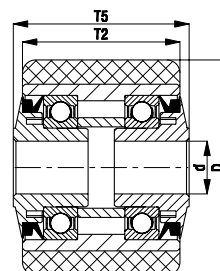

## HTHW series, dimensions 85x85-85x110 mm

**Rollers for pallet trucks with Blickle Extrathane® polyurethane tread, metal wheel centre, splash and washproof**



820–1,060 kg

**Tread and tyre hardness**

92 Shore A

**Smooth operation / floor preservation**

good

**Rolling resistance**

very good

**Wear resistance**

excellent



**Tread:**

- high-quality polyurethane elastomer Blickle Extrathane®, hardness 92 Shore A
- low rolling resistance
- high abrasion resistance
- high cut and tear propagation resistance
- colour light brown, non-marking, non-staining
- excellent chemical connection with the wheel centre

**Wheel centre:**

- metal

**Other features:**

- high chemical resistance to many aggressive substances
- operating temperature: -20 °C to +70 °C, temporarily up to +90 °C, reduced load capacity over +40 °C
- optimal splash and washproof for ball bearing through combination of clearance sealing and slipping sealing

**Additional details:**

- wheel series: page 79
- tread: page 55
- bearing types: page 84–85
- chemical resistance: page 51

Rollers for pallet trucks	Wheel Ø	Wheel width	Load capacity	Bearing type	Axle bore Ø	Clamping length
	(D) [mm]	(T2) [mm]	[kg]		(d) [mm]	(T5) [mm]
HTHW 85x85/12-90K	85	85	820	ball bearing	12	90
HTHW 85x85/17-90K	85	85	820	ball bearing	17	90
HTHW 85x85/20-90K	85	85	820	ball bearing	20	90
HTHW 85x85/25-90K	85	85	820	ball bearing	25	90
HTHW 85x90/12-95K	85	90	850	ball bearing	12	95
HTHW 85x90/17-95K	85	90	850	ball bearing	17	95
HTHW 85x90/20-95K	85	90	850	ball bearing	20	95
HTHW 85x90/25-95K	85	90	850	ball bearing	25	95
HTHW 85x95/12-100K	85	95	910	ball bearing	12	100
HTHW 85x95/17-100K	85	95	910	ball bearing	17	100
HTHW 85x95/20-100K	85	95	910	ball bearing	20	100
HTHW 85x95/25-100K	85	95	910	ball bearing	25	100
HTHW 85x100/12-105K	85	100	960	ball bearing	12	105
HTHW 85x100/17-105K	85	100	960	ball bearing	17	105
HTHW 85x100/20-105K	85	100	960	ball bearing	20	105
HTHW 85x100/25-105K	85	100	960	ball bearing	25	105
HTHW 85x105/12-110K	85	105	1,010	ball bearing	12	110
HTHW 85x105/17-110K	85	105	1,010	ball bearing	17	110
HTHW 85x105/20-110K	85	105	1,010	ball bearing	20	110
HTHW 85x105/25-110K	85	105	1,010	ball bearing	25	110
HTHW 85x110/12-115K	85	110	1,060	ball bearing	12	115
HTHW 85x110/17-115K	85	110	1,060	ball bearing	17	115
HTHW 85x110/20-115K	85	110	1,060	ball bearing	20	115
HTHW 85x110/25-115K	85	110	1,060	ball bearing	25	115

Other dimensions available upon request

**Versions / options**

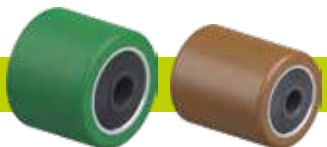

with Blickle Softhane® polyurethane tread	with Blickle Besthane® polyurethane tread
---	---

Technical description page	55	56
<b>Product code suffix</b>	<b>HSTW series</b>	<b>HBW series</b>
Available for	upon request*	upon request

\* Hardness 75 Shore A

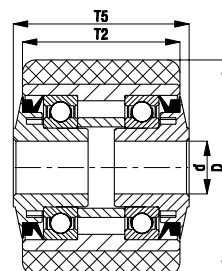

# HPO series

## Nylon rollers for pallet trucks



420–1,100 kg

**Tread and tyre hardness**  
 70 Shore D

**Smooth operation / floor preservation**  
 satisfactory

**Rolling resistance**  
 excellent

**Wear resistance**  
 good

**Roller for pallet trucks:**

- high-quality nylon 6, impact resistant, hardness 70 Shore D
- very low rolling resistance
- easy operation on smooth surfaces
- high abrasion resistance
- colour natural white

**Other features:**

- high chemical resistance to many aggressive substances
- operating temperature: -20 °C to +80 °C, reduced load capacity over +35 °C

**Additional details:**

- wheel series: page 79
- tread: page 57
- bearing types: page 84–85
- chemical resistance: page 51

Rollers for pallet trucks	Wheel Ø	Wheel width	Load capacity	ball bearing	Axle bore Ø	Clamping length
	(D) [mm]	(T2) [mm]	[kg]		(d) [mm]	(T5) [mm]
HPO 80x61/20-67K	80	61	600	6204 ZZV	20	67
HPO 80x70/20-76K	80	70	650	6204 ZZV	20	76
HPO 80x74/20-80K	80	74	700	6204 ZZV	20	80
HPO 82x54/20-54K	82	54	600	6204 ZZ	20	54
HPO 82x54/20-60K	82	54	600	6204 ZZV	20	60
HPO 82x60/20-60K	82	60	610	6204 ZZ	20	60
HPO 82x60/25-60K	82	60	610	6005 ZZ	25	60
HPO 82x62/20-65K	82	62	620	6204 ZZV	20	65
HPO 82x64/20-64K	82	64	650	6204 ZZ	20	64
HPO 82x66/20-72K	82	66	675	6204 ZZV	20	72
HPO 82x68/20-74K	82	68	675	6204 ZZV	20	74
HPO 82x70/20-62K	82	70	700	6204 ZZ	20	62
HPO 82x70/20-70K	82	70	700	6204 ZZ	20	70
HPO 82x73/20-79K	82	73	700	6204 ZZV	20	79
HPO 82x75/20-75K	82	75	750	6204 ZZ	20	75
HPO 82x79/20-85K	82	79	800	6204 ZZV	20	85
HPO 82x80/20-80K	82	80	800	6204 ZZ	20	80
HPO 82x84/20-84K	82	84	850	6204 ZZ	20	84
HPO 82x91/20-97K	82	91	900	6204 ZZV	20	97
HPO 82x93/20-93K	82	93	900	6204 ZZ	20	93
HPO 82x98/20-98K	82	98	975	6204 ZZ	20	98
HPO 82x100/20-100K	82	100	1,000	6204 ZZ	20	100
HPO 85x40/20-40K	85	40	420	6204 ZZ	20	40
HPO 85x60/17-60K	85	60	650	6303 ZZ	17	60
HPO 85x60/20-60K	85	60	650	6204 ZZ	20	60
HPO 85x65/20-65K	85	65	700	6204 ZZ	20	65
HPO 85x70/20-70K	85	70	750	6204 ZZ	20	70
HPO 85x75/17-78K *	85	75	800	6006 2RS	17	78
HPO 85x75/20-75K	85	75	800	6204 ZZ	20	75
HPO 85x80/20-80K	85	80	850	6204 ZZ	20	80
HPO 85x85/20-85K	85	85	900	6204 ZZ	20	85
HPO 85x90/20-90K	85	90	950	6204 ZZ	20	90
HPO 85x100/17-103K *	85	100	1,100	6006 2RS	17	103
HPO 85x100/20-100K	85	100	1,100	6204 ZZ	20	100

\* With nylon socket

Other dimensions available upon request

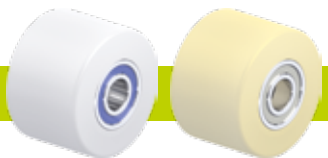

**Versions / options**

	with stainless steel ball bearing in the wheel hub	made from cast nylon for increased load capacity
Technical description page	84	57
Product code suffix	-XK	HGSP0 series
Available for	upon request**	upon request

\*\* Some dimensions may result in reduced load capacities

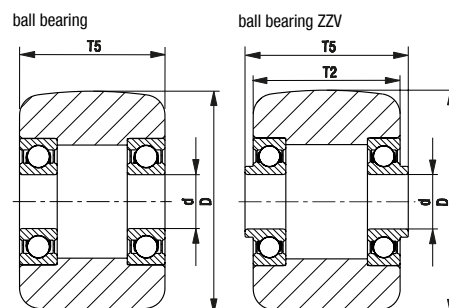

# ALEV, ALST, ALTH, PO series

## Front wheels for pallet trucks

500–800 kg



**Wheel:** ALEV series

- tyre: high-quality elastic solid rubber “Blickle EasyRoll” in smooth rolling quality, hardness 65 Shore A, colour black
- wheel centre: die-cast aluminium
- overview wheel series page 63

**Wheel:** ALST series

- tread: high-quality polyurethane elastomer Blickle Softhane®, hardness 75 Shore A, colour green, non-marking, non-staining
- wheel centre: die-cast aluminium
- overview wheel series page 66

**Wheel:** ALTH series

- tread: high-quality polyurethane elastomer Blickle Extrathane®, hardness 92 Shore A, colour light brown, non-marking, non-staining
- wheel centre: die-cast aluminium
- overview wheel series page 65

**Wheel:** PO series

- high-quality nylon 6, impact resistant, hardness 70 Shore D, colour natural white
- overview wheel series page 69

Wheels	Wheel Ø (D) [mm]	Wheel width (T2) [mm]	Load capacity at 4 km/h [kg]	Load capacity at 10 km/h [kg]	Bearing type	Axle bore Ø (d) [mm]	Hub length (T1) [mm]	Clamping length (T5) [mm]
<b>ALEV series</b>								
ALEV 200x50/20-54K	200	50	500	250	ball bearing	20	60	54
ALEV 200x50/25-50K	200	50	500	250	ball bearing	25	60	50
<b>ALST series</b>								
ALST 200x50/20-54K	200	50	700	300	ball bearing	20	60	54
ALST 200x50/25-50K	200	50	700	300	ball bearing	25	60	50
<b>ALTH series</b>								
ALTH 180x50/20-54K	180	50	700	350	ball bearing	20	60	54
ALTH 180x50/25-50K	180	50	700	350	ball bearing	25	60	50
ALTH 200x50/20-40K	200	50	800	400	ball bearing	20	50	40
ALTH 200x50/20-54K	200	50	800	400	ball bearing	20	60	54
ALTH 200x50/25-36K	200	50	800	400	ball bearing	25	50	36
ALTH 200x50/25-50K	200	50	800	400	ball bearing	25	60	50
<b>PO series</b>								
PO 200x50/20-54K	200	50	600	–	ball bearing	20	60	54
PO 200x50/25-50K	200	50	600	–	ball bearing	25	60	50

### Versions / options



with stainless steel ball bearing in the wheel hub

Technical description page	84
Product code suffix	-XK
Available for	upon request

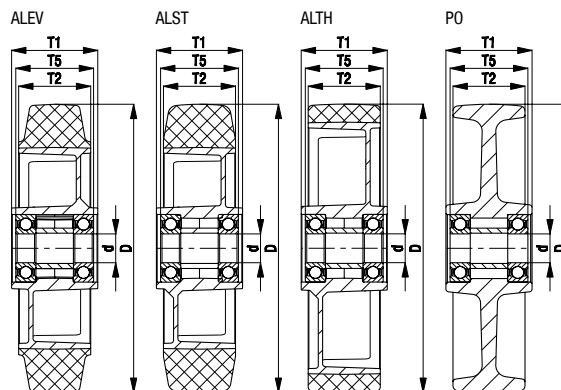

## ALH, GTH, VSTH series

**Heavy-duty wheels**  
with **Blickle Extrathane®** polyurethane tread,  
with aluminium, cast iron or steel wheel centre

360–1,100 kg

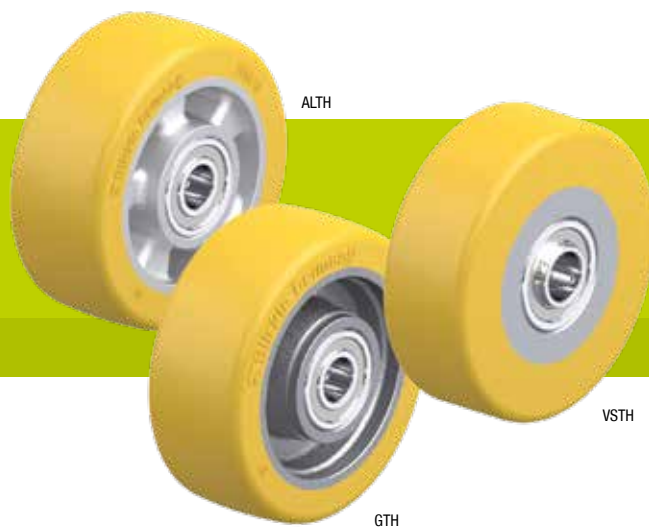

### Wheel: ALH series

- tread: high-quality polyurethane elastomer Blickle Extrathane®, hardness 92 Shore A, colour light brown, non-marking, non-staining
- wheel centre: die-cast aluminium
- overview wheel series page 65

### Wheel: GTH series

- tread: high-quality polyurethane elastomer Blickle Extrathane®, hardness 92 Shore A, colour light brown, non-marking, non-staining
- wheel centre: rugged grey cast iron, lacquered, colour silver, with grease nipple from wheel Ø 150 mm
- overview wheel series page 66

### Wheel: VSTH series

- tread: high-quality polyurethane elastomer Blickle Extrathane®, hardness 92 Shore A, colour light brown, non-marking, non-staining
- wheel centre: steel
- overview wheel series page 66

Wheels	Wheel Ø (D) [mm]	Wheel width (T2) [mm]	Load capacity at 4 km/h [kg]	Load capacity at 10 km/h [kg]	Bearing type	Axle bore Ø (d) [mm]	Hub length (T1) [mm]	Clamping length (T5) [mm]
<b>ALH series</b>								
ALH 101/15K *	100	40	420	–	ball bearing	15	40	40
ALH 140/20K	140	54	800	400	ball bearing	20	60	60
<b>GTH series</b>								
GTH 101/20-50K	100	50	600	–	ball bearing	20	50	50
GTH 110x50/20-46K	110	50	650	–	ball bearing	20	50	46
GTH 125x40/20-48K	125	40	550	–	ball bearing	20	50	48
GTH 127/20-50K	125	50	700	350	ball bearing	20	50	50
GTH 127/25-50K	125	50	700	350	ball bearing	25	50	50
GTH 140X59/20-68K	140	59	800	400	ball bearing	20	68	68
GTH 140X59/25-54K	140	59	800	400	ball bearing	25	68	54
GTH 150/20-50K	150	50	800	400	ball bearing	20	50	50
GTH 150/20-58K	150	50	800	400	ball bearing	20	60	58
GTH 150X54/20-60K	150	54	850	420	ball bearing	20	60	60
GTH 150X55/25-59K	150	55	850	420	ball bearing	25	57	59
GTH 182/25K	180	65	1,100	550	ball bearing	25	75	75
<b>VSTH series</b>								
VSTH 100x40/20-40K	100	40	360	–	ball bearing	20	40	40
VSTH 100x40/20-44K	100	40	360	–	ball bearing	20	44	44
VSTH 100x40/20-43K	100	40	360	–	ball bearing	20	45	43
VSTH 100x40/25-40K	100	40	360	–	ball bearing	25	40	40
VSTH 120x50/25-50K	120	50	540	–	ball bearing	25	50	50
VSTH 125x43/20-49K	125	43	480	–	ball bearing	20	43	49

\* With heavy-duty wheel centre, reinforced design

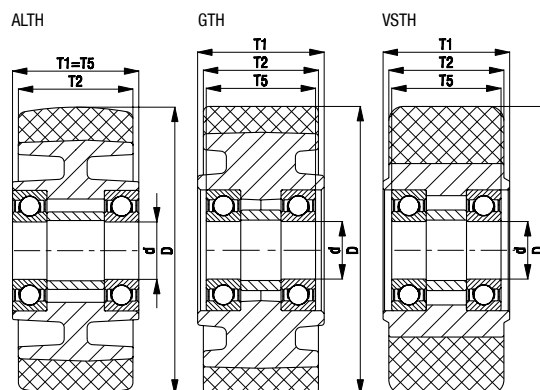

## GB series

**Heavy-duty wheels**  
with **Blickle Besthane® polyurethane tread**,  
with **cast iron wheel centre**



450–1,200 kg

**Tread and tyre hardness**  
 92 Shore A

**Smooth operation / floor preservation**  
 good

**Rolling resistance**  
 excellent

**Wear resistance**  
 excellent



### Tread:

- high-quality polyurethane elastomer Blickle Besthane®, hardness 92 Shore A
- very low rolling resistance
- **high dynamic load capacity**
- high abrasion resistance
- high cut and tear propagation resistance
- colour brown, non-marking, non-staining
- excellent chemical connection with the wheel centre

### Wheel centre:

- rugged grey cast iron
- with grease nipple from wheel Ø 150 mm
- lacquered, colour silver

### Other features:

- high chemical resistance to many aggressive substances
- operating temperature: -20 °C to +70 °C, temporarily up to +90 °C, reduced load capacity over +40 °C

### Additional details:

- wheel series: page 67
- tread: page 56
- bearing types: page 84–85
- chemical resistance: page 51

Wheels	Wheel Ø (D) [mm]	Wheel width (T2) [mm]	Load capacity at 4 km/h [kg]	Load capacity at 10 km/h [kg]	Load capacity at 16 km/h [kg]	Bearing type	Axle bore Ø (d) [mm]	Hub length (T1) [mm]	Clamping length (T5) [mm]
<b>GB 100/15K</b>	100	40	450	–	–	ball bearing	15	40	40
<b>GB 101/20-50K</b>	100	50	600	–	–	ball bearing	20	50	50
<b>GB 128/20K</b>	125	60	850	590	340	ball bearing	20	60	60
<b>GB 140/20K</b>	140	54	900	630	360	ball bearing	20	60	60
<b>GB 150/20-50K</b>	150	50	800	560	320	ball bearing	20	50	50
<b>GB 150x54/20-60K</b>	150	54	950	660	380	ball bearing	20	60	60
<b>GB 154/25-78K</b>	150	80	1,200	840	480	ball bearing	25	78	78
<b>GB 182/25K</b>	180	65	1,100	770	440	ball bearing	25	75	75

Greatly increased load capacity is possible for applications without obstacles.

For other dimensions, see page 312

## Versions / options



hydrolysis resistant,  
with cast nylon wheel  
centre

Technical description page	56
<b>Product code suffix</b>	<b>GSPOB series</b>
Available for	upon request

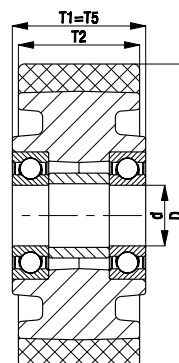

## GVU series

### Heavy-duty wheels with Vulkollan® tread, with cast iron wheel centre

450–1,200 kg

#### Tread and tyre hardness

92 Shore A

#### Smooth operation / floor preservation

good

#### Rolling resistance

very good

#### Wear resistance

excellent



#### Tread:

- high-quality polyurethane elastomer Vulkollan®, hardness 92 Shore A
- low rolling resistance
- **high dynamic load capacity**
- high abrasion resistance
- high cut and tear propagation resistance
- colour natural, non-marking, non-staining
- excellent chemical connection with the wheel centre

#### Wheel centre:

- rugged grey cast iron
- with grease nipple from wheel Ø 150 mm
- lacquered, colour silver

#### Other features:

- high chemical resistance to many aggressive substances
- operating temperature: -20 °C to +70 °C, temporarily up to +90 °C, reduced load capacity over +40 °C

#### Additional details:

- wheel series: page 68
- tread: page 56
- bearing types: page 84–85
- chemical resistance: page 51



Wheels	Wheel Ø (D) [mm]	Wheel width (T2) [mm]	Load capacity at 4 km/h [kg]	Load capacity at 10 km/h [kg]	Load capacity at 16 km/h [kg]	Bearing type	Axle bore Ø (d) [mm]	Hub length (T1) [mm]	Clamping length (T5) [mm]
GVU 100/15K	100	40	450	–	–	ball bearing	15	40	40
GVU 101/20-50K	100	50	600	–	–	ball bearing	20	50	50
GVU 128/20K	125	60	850	590	340	ball bearing	20	60	60
GVU 140/20K	140	54	900	630	360	ball bearing	20	60	60
GVU 150/20-50K	150	50	800	560	320	ball bearing	20	50	50
GVU 150x54/20-60K	150	54	850	590	340	ball bearing	20	60	60
GVU 154/25-78K	150	80	1,200	840	480	ball bearing	25	80	80
GVU 182/25K	180	65	1,100	770	440	ball bearing	25	75	75

For other dimensions, see page 326

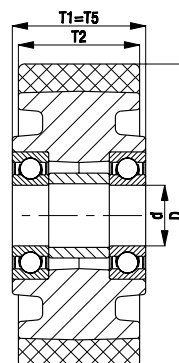



## RTH, RB, REV series

**Wheels for stackers,  
drive and running wheels  
for forklift trucks**



### Wheel: RTH series

- tread: high-quality polyurethane elastomer Blickle Extrathane®, hardness 92 Shore A, low rolling resistance, high abrasion resistance, high cut and tear propagation resistance, colour light brown, non-marking, non-staining, excellent chemical connection with the wheel centre (see page 55 for a material description)
- wheel centre: rugged grey cast iron or ductile cast iron
- overview wheel series page 79

### Wheel: RB series

- tread: high-quality polyurethane elastomer Blickle Besthane®, hardness 92 Shore A, very low rolling resistance, **high dynamic load capacity**, high abrasion resistance, high cut and tear propagation resistance, colour brown, non-marking, non-staining, excellent chemical connection with the wheel centre (see page 56 for a material description)
- wheel centre: rugged grey cast iron or ductile cast iron
- overview wheel series page 80

### Wheel: REV series

- tyre: high-quality elastic solid rubber in drive-quality, hardness 70 Shore A, very good operational comfort, very good floor preservation, low-noise operation, colour black, non-marking (see page 53 for a material description)
- wheel centre: rugged grey cast iron or ductile cast iron
- overview wheel series page 79

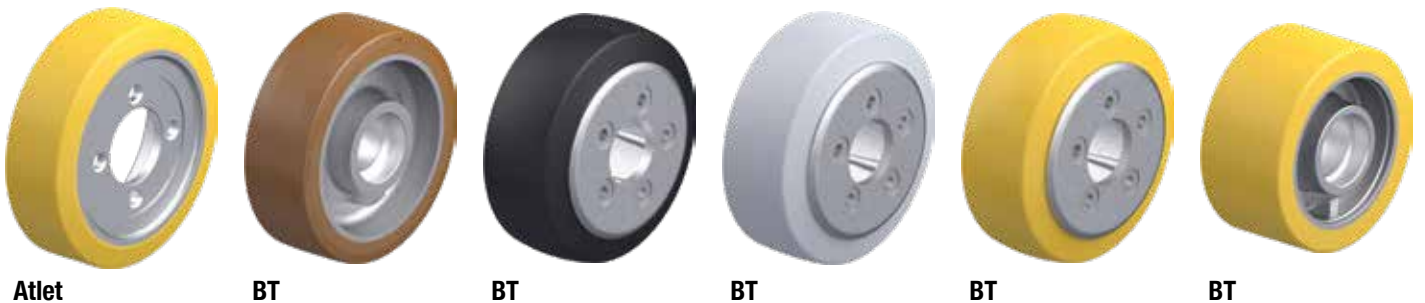

Suitable for manufacturer no.	Suitable for manufacturer no.	Suitable for manufacturer no.	Suitable for manufacturer no.	Suitable for manufacturer no.	Suitable for manufacturer no.
<b>78120</b>	<b>74559</b>	<b>129938</b>	<b>127352</b>	<b>129920</b>	<b>133862</b>
Product code	Product code	Product code	Product code	Product code	Product code
<b>RTH 255x75/80-4</b>	<b>RB 300x100/90x28</b>	<b>REV 215x82/60-5</b>	<b>REV 215x82/60-5-SG</b>	<b>RTH 215x82/60-5</b>	<b>RTH 230x110/80x25</b>

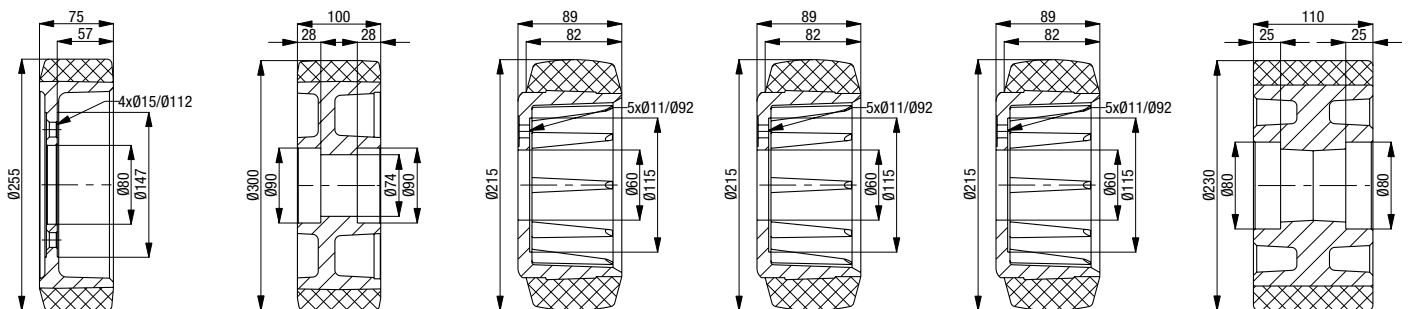

Other dimensions available upon request

## RTH, RB, REV series

**Wheels for stackers,  
drive and running wheels  
for forklift trucks**



**Wheel: RTH series**

- tread: high-quality polyurethane elastomer Blickle Extrathane®, hardness 92 Shore A, low rolling resistance, high abrasion resistance, high cut and tear propagation resistance, colour light brown, non-marking, non-staining, excellent chemical connection with the wheel centre (see page 55 for a material description)
- wheel centre: rugged grey cast iron or ductile cast iron
- overview wheel series page 79

**Wheel: RB series**

- tread: high-quality polyurethane elastomer Blickle Besthane®, hardness 92 Shore A, very low rolling resistance, **high dynamic load capacity**, high abrasion resistance, high cut and tear propagation resistance, colour brown, non-marking, non-staining, excellent chemical connection with the wheel centre (see page 56 for a material description)
- wheel centre: rugged grey cast iron or ductile cast iron
- overview wheel series page 80

**Wheel: REV series**

- tyre: high-quality elastic solid rubber in drive-quality, hardness 70 Shore A, very good operational comfort, very good floor preservation, low-noise operation, colour black (see page 53 for a material description)
- wheel centre: rugged grey cast iron or ductile cast iron
- overview wheel series page 79



**BT**



**BV**



**BV**



**BV**



**Fenwick-Linde**



**Fenwick-Linde**

Suitable for manufacturer no.	Suitable for manufacturer no.	Suitable for manufacturer no.	Suitable for manufacturer no.	Suitable for manufacturer no.	Suitable for manufacturer no.
138457	3070056	3070053	3070068	29903814	39902305
Product code	Product code	Product code	Product code	Product code	Product code
RTH 250x75/80-5	REV 230x70/45-5+3	RTH 230x70/45-5+3	RTH 230x75/80-6	RB 343x135/90-7	RTH 230x90/65-4

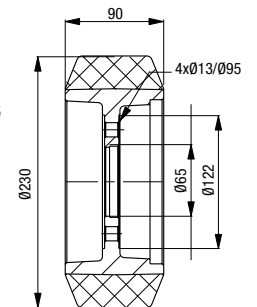
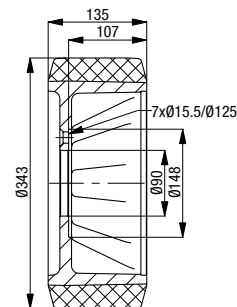
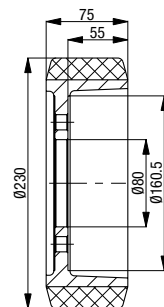
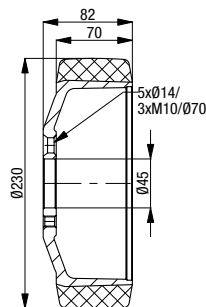
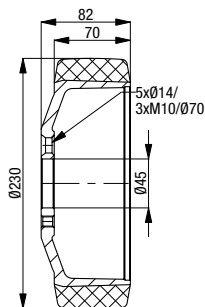
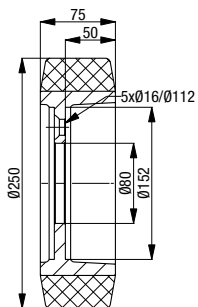

Other dimensions available upon request

## RTH, RB, REV series

**Wheels for stackers,  
drive and running wheels  
for forklift trucks**



### Wheel: RTH series

- tread: high-quality polyurethane elastomer Blickle Extrathane®, hardness 92 Shore A, low rolling resistance, high abrasion resistance, high cut and tear propagation resistance, colour light brown, non-marking, non-staining, excellent chemical connection with the wheel centre (see page 55 for a material description)
- wheel centre: rugged grey cast iron or ductile cast iron
- overview wheel series page 79

### Wheel: RB series

- tread: high-quality polyurethane elastomer Blickle Besthane®, hardness 92 Shore A, very low rolling resistance, **high dynamic load capacity**, high abrasion resistance, high cut and tear propagation resistance, colour brown, non-marking, non-staining, excellent chemical connection with the wheel centre (see page 56 for a material description)
- wheel centre: rugged grey cast iron or ductile cast iron
- overview wheel series page 80

### Wheel: REV series

- tyre: high-quality elastic solid rubber in drive-quality, hardness 70 Shore A, very good operational comfort, very good floor preservation, low-noise operation, colour black (see page 53 for a material description)
- wheel centre: rugged grey cast iron or ductile cast iron
- overview wheel series page 79



**Fenwick-Linde**



**Fenwick-Linde**



**Fenwick-Linde**



**Fenwick-Linde**



**Fenwick-Linde**



**Fenwick-Linde**

Suitable for manufacturer no.	Suitable for manufacturer no.	Suitable for manufacturer no.	Suitable for manufacturer no.	Suitable for manufacturer no.	Suitable for manufacturer no.
<b>39933826</b>	<b>39902311</b>	<b>39933824</b>	<b>39902310</b>	<b>39902308</b>	<b>39933826</b>
Product code	Product code	Product code	Product code	Product code	Product code
<b>RB 230x90/45-5</b>	<b>RB 254x102/80-5</b>	<b>REV 230x90/45-5</b>	<b>REV 230x90/65-4</b>	<b>REV 254x102/80-5</b>	<b>RTH 230x90/45-5</b>

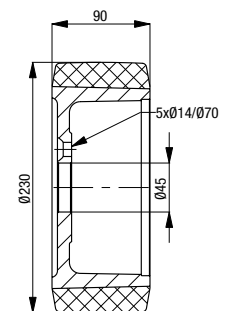
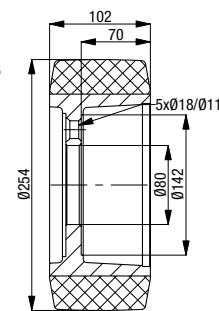
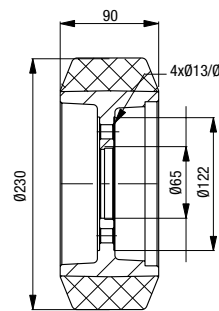
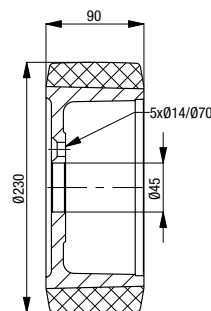
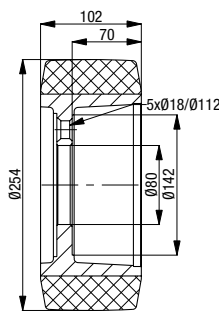
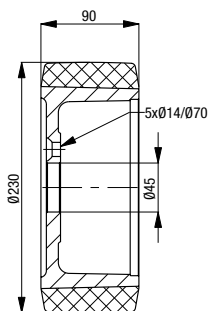

Other dimensions available upon request

## RTH, RB, REV series

**Wheels for stackers,  
drive and running wheels  
for forklift trucks**

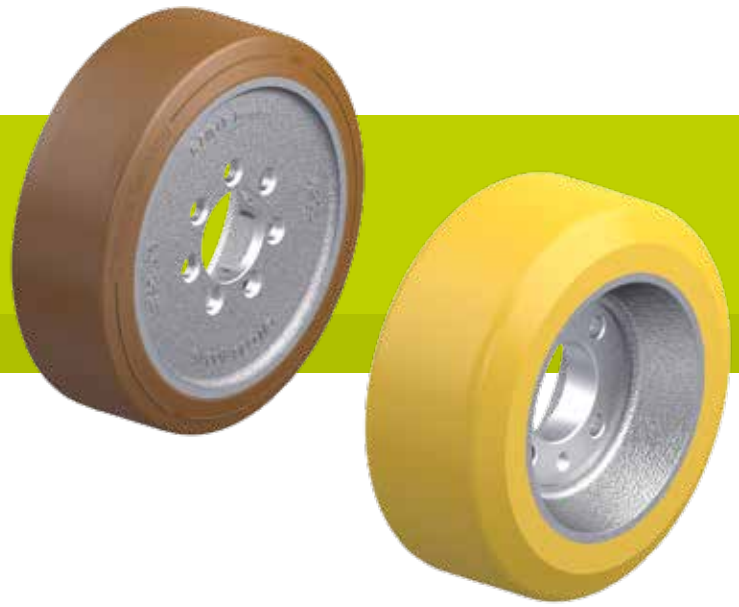

### Wheel: RTH series

- tread: high-quality polyurethane elastomer Blickle Extrathane®, hardness 92 Shore A, low rolling resistance, high abrasion resistance, high cut and tear propagation resistance, colour light brown, non-marking, non-staining, excellent chemical connection with the wheel centre (see page 55 for a material description)
- wheel centre: rugged grey cast iron or ductile cast iron
- overview wheel series page 79

### Wheel: RB series

- tread: high-quality polyurethane elastomer Blickle Besthane®, hardness 92 Shore A, very low rolling resistance, **high dynamic load capacity**, high abrasion resistance, high cut and tear propagation resistance, colour brown, non-marking, non-staining, excellent chemical connection with the wheel centre (see page 56 for a material description)
- wheel centre: rugged grey cast iron or ductile cast iron
- overview wheel series page 80

### Wheel: REV series

- tyre: high-quality elastic solid rubber in drive-quality, hardness 70 Shore A, very good operational comfort, very good floor preservation, low-noise operation, colour black (see page 53 for a material description)
- wheel centre: rugged grey cast iron or ductile cast iron
- overview wheel series page 79



**Fenwick-Linde**



**Jungheinrich**



**Jungheinrich**



**Jungheinrich**



**Jungheinrich**



**Jungheinrich**

Suitable for manufacturer no.	Suitable for manufacturer no.	Suitable for manufacturer no.	Suitable for manufacturer no.	Suitable for manufacturer no.	Suitable for manufacturer no.
<b>9815054219</b>	<b>51130049</b>	<b>6313503</b>	<b>6319050</b>	<b>7130113</b>	<b>6315408</b>
Product code	Product code	Product code	Product code	Product code	Product code
<b>RB 343x135/80-7</b>	<b>RB 343x110/90-7</b>	<b>RB 343x114/80-7</b>	<b>REV 230x70/45-5+3</b>	<b>REV 250x80/30-90-N</b>	<b>RTH 200x85/50-4+2</b>

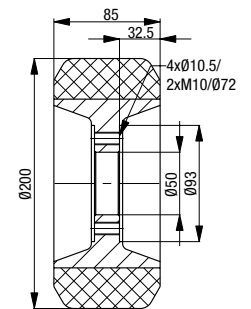
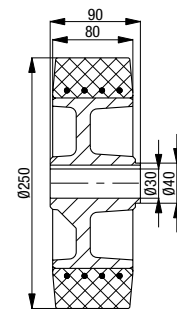
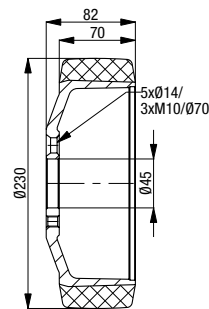
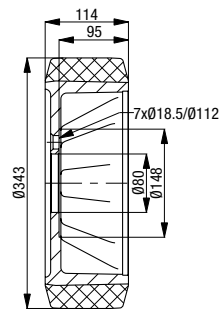
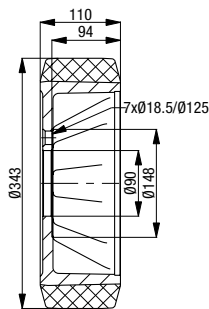
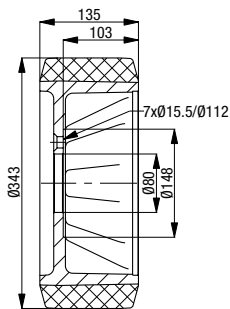

Other dimensions available upon request

## RTH, RB series

**Wheels for stackers,  
drive and running wheels  
for forklift trucks**

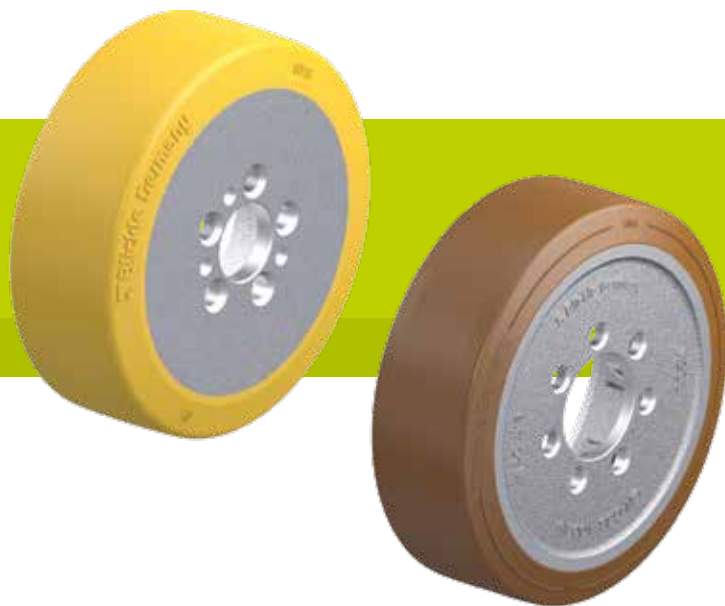

### Wheel: RTH series

- tread: high-quality polyurethane elastomer Blickle Extrathane®, hardness 92 Shore A, low rolling resistance, high abrasion resistance, high cut and tear propagation resistance, colour light brown, non-marking, non-staining, excellent chemical connection with the wheel centre (see page 55 for a material description)
- wheel centre: rugged grey cast iron or ductile cast iron
- overview wheel series page 79

### Wheel: RB series

- tread: high-quality polyurethane elastomer Blickle Besthane®, hardness 92 Shore A, very low rolling resistance, **high dynamic load capacity**, high abrasion resistance, high cut and tear propagation resistance, colour brown, non-marking, non-staining, excellent chemical connection with the wheel centre (see page 56 for a material description)
- wheel centre: rugged grey cast iron or ductile cast iron
- overview wheel series page 80



**Jungheinrich**



**Jungheinrich**



**Jungheinrich**



**Jungheinrich**



**Jungheinrich**



**Jungheinrich**

Suitable for manufacturer no.	Suitable for manufacturer no.	Suitable for manufacturer no.	Suitable for manufacturer no.	Suitable for manufacturer no.	Suitable for manufacturer no.
50262633	63145890	50429920	77800067	63215600	7134004
Product code	Product code	Product code	Product code	Product code	Product code
RB 343x114/90-7	RB 343x140/80-7	RB 343x140/90-7	RTH 230x80/65-4-75SH	RTH 230x82/45-5+3	RTH 230x85/50-4-GL

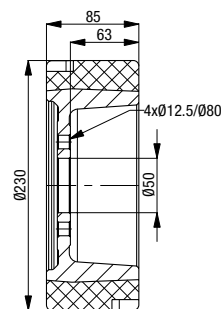
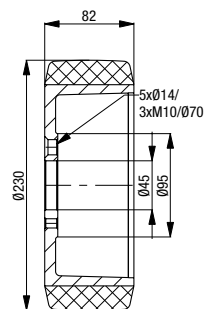
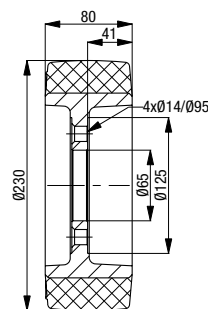
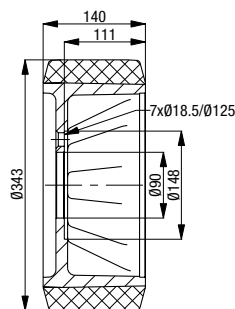
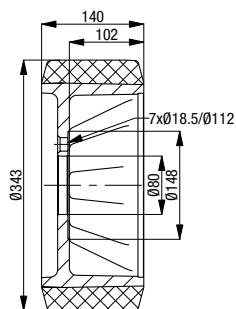
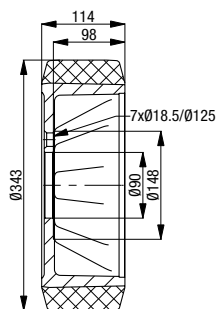

Other dimensions available upon request

## RTH, REV, RVU series

**Wheels for stackers,  
drive and running wheels  
for forklift trucks**



### Wheel: RTH series

- tread: high-quality polyurethane elastomer Blickle Extrathane®, hardness 92 Shore A, low rolling resistance, high abrasion resistance, high cut and tear propagation resistance, colour light brown, non-marking, non-staining, excellent chemical connection with the wheel centre (see page 55 for a material description)
- wheel centre: rugged grey cast iron or ductile cast iron
- overview wheel series page 79

### Wheel: REV series

- tyre: high-quality elastic solid rubber in drive-quality, hardness 70 Shore A, very good operational comfort, very good floor preservation, low-noise operation, colour black (see page 53 for a material description)
- wheel centre: rugged grey cast iron or ductile cast iron
- overview wheel series page 79

### Wheel: RVU series

- tread: high-quality polyurethane elastomer Vulkollan®, hardness 92 Shore A, low rolling resistance, **high dynamic load capacity**, high abrasion resistance, high cut and tear propagation resistance, colour natural, non-marking, excellent chemical connection with the wheel centre (see page 56 for a material description)
- wheel centre: rugged grey cast iron or ductile cast iron
- overview wheel series page 80



**Jungheinrich**



**Loc**



**Mic**



**Mic**



**Mic**



**Mic**

Suitable for manufacturer no.	Suitable for manufacturer no.	Suitable for manufacturer no.	Suitable for manufacturer no.	Suitable for manufacturer no.	Suitable for manufacturer no.
9903813	539134	28862	506318547	58259	200117240
Product code	Product code	Product code	Product code	Product code	Product code
RVU 250x100/80-5	RTH 270x90/157-12	REV 250x80/30-90-N	RTH 200x85/50-4+2	RTH 230x85/50-4-GL	RTH 270x95/157-12

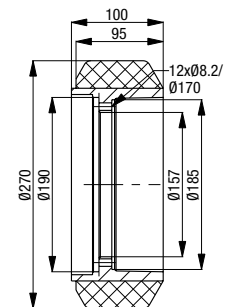
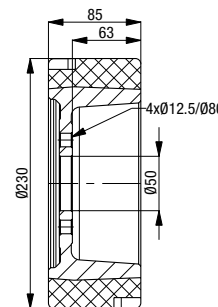
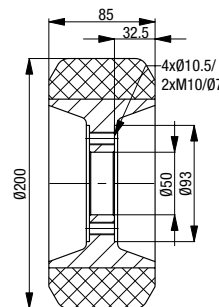
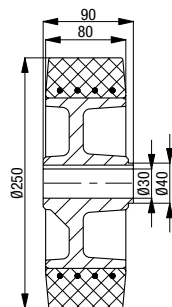
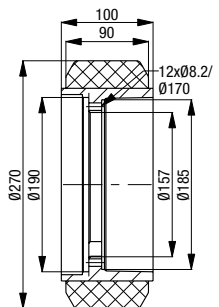
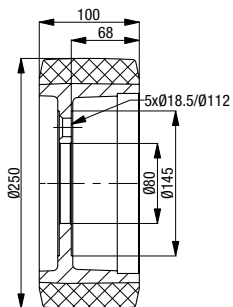

Other dimensions available upon request

## RTH series

**Wheels for stackers,  
drive and running wheels  
for forklift trucks**



**Wheel:** RTH series

- tread: high-quality polyurethane elastomer Blickle Extrathane®, hardness 92 Shore A, low rolling resistance, high abrasion resistance, high cut and tear propagation resistance, colour light brown, non-marking, non-staining, excellent chemical connection with the wheel centre  
(see page 55 for a material description)
- wheel centre: rugged grey cast iron or ductile cast iron
- overview wheel series page 79



**Pimespo**



**Pimespo**



**Pimespo**



**Prat**



**Prat**



**Steinbock**

Suitable for manufacturer no.	Suitable for manufacturer no.	Suitable for manufacturer no.	Suitable for manufacturer no.	Suitable for manufacturer no.	Suitable for manufacturer no.
95309393	95309172	81504005	68352	55667	29093
Product code	Product code	Product code	Product code	Product code	Product code
RTH 230x70/45-5+3	RTH 230x75/80-6	RTH 250x80/80-5-PI	RTH 225x70/120-12-P	RTH 230x72/10-6-P	RTH 270x90/211

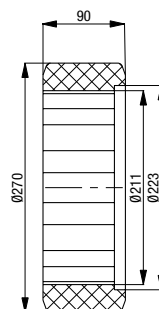
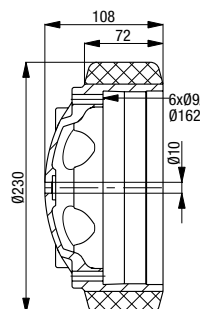
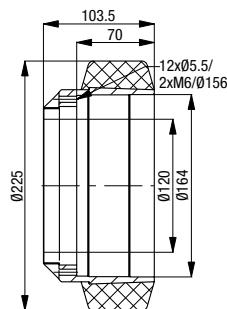
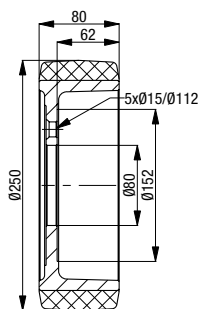
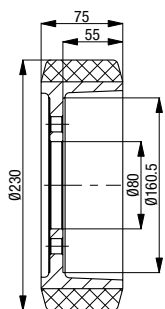
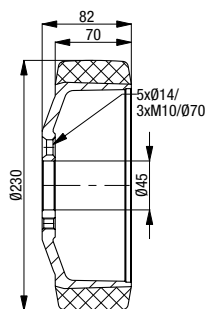

Other dimensions available upon request

## RTH, RB, RVU series

**Wheels for stackers,  
drive and running wheels  
for forklift trucks**



**Wheel: RTH series**

- tread: high-quality polyurethane elastomer Blickle Extrathane®, hardness 92 Shore A, low rolling resistance, high abrasion resistance, high cut and tear propagation resistance, colour light brown, non-marking, non-staining, excellent chemical connection with the wheel centre (see page 55 for a material description)
- wheel centre: rugged grey cast iron or ductile cast iron
- overview wheel series page 79

**Wheel: RB series**

- tread: high-quality polyurethane elastomer Blickle Besthane®, hardness 92 Shore A, very low rolling resistance, **high dynamic load capacity**, high abrasion resistance, high cut and tear propagation resistance, colour brown, non-marking, non-staining, excellent chemical connection with the wheel centre (see page 56 for a material description)
- wheel centre: rugged grey cast iron or ductile cast iron
- overview wheel series page 80

**Wheel: RVU series**

- tread: high-quality polyurethane elastomer Vulkollan®, hardness 92 Shore A, low rolling resistance, **high dynamic load capacity**, high abrasion resistance, high cut and tear propagation resistance, colour natural, non-marking, excellent chemical connection with the wheel centre (see page 56 for a material description)
- wheel centre: rugged grey cast iron or ductile cast iron
- overview wheel series page 80



Suitable for manufacturer no.	Suitable for manufacturer no.	Suitable for manufacturer no.	Suitable for manufacturer no.	Suitable for manufacturer no.	Suitable for manufacturer no.
359920	9903803	9933831	359920	5453870	4400716
Product code	Product code	Product code	Product code	Product code	Product code
RB 230x75/45-5	RB 250x100/80-5	RB 260x80/150-8+2	RTH 230x75/45-5	RTH 230x85/50-4-GL	RVU 230x70/45-5+3

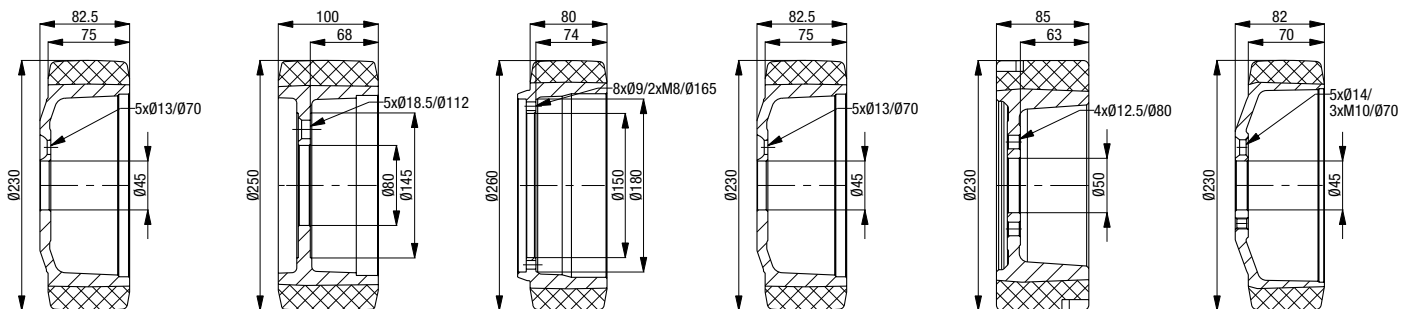

Other dimensions available upon request



## RTH, RB series

**Wheels for stackers,  
drive and running wheels  
for forklift trucks**



### Wheel: RTH series

- tread: high-quality polyurethane elastomer Blickle Extrathane®, hardness 92 Shore A, low rolling resistance, high abrasion resistance, high cut and tear propagation resistance, colour light brown, non-marking, non-staining, excellent chemical connection with the wheel centre (see page 55 for a material description)
- wheel centre: rugged grey cast iron or ductile cast iron
- overview wheel series page 79

### Wheel: RB series

- tread: high-quality polyurethane elastomer Blickle Besthane®, hardness 92 Shore A, very low rolling resistance, **high dynamic load capacity**, high abrasion resistance, high cut and tear propagation resistance, colour brown, non-marking, non-staining, excellent chemical connection with the wheel centre (see page 56 for a material description)
- wheel centre: rugged grey cast iron or ductile cast iron
- overview wheel series page 80



**Still**



**Stöcklin**



**Wagner**



**Wagner**



**Wagner**

Suitable for manufacturer no.	Suitable for manufacturer no.	Suitable for manufacturer no.	Suitable for manufacturer no.	Suitable for manufacturer no.
<b>359920</b>	<b>360503</b>	<b>334295</b>	<b>359920</b>	<b>305061</b>
Product code	Product code	Product code	Product code	Product code
<b>RTH 230x75/45-5</b>	<b>RTH 255x83/80-5</b>	<b>RB 300x100/80-5</b>	<b>RTH 230x75/45-5</b>	<b>RTH 255x83/80-5</b>

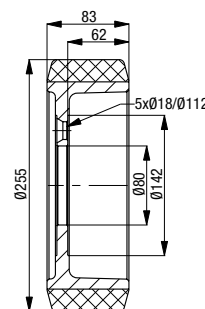
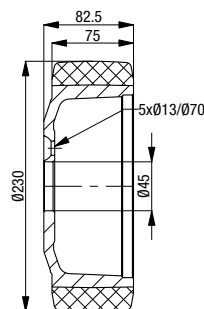
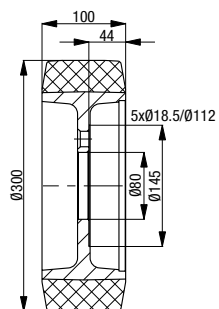
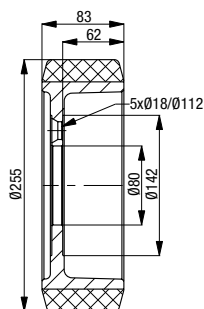
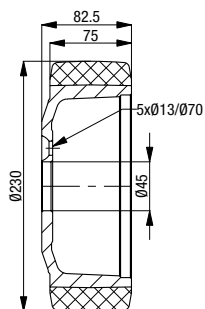

Other dimensions available upon request